

Raceway Solutions™

Flush Activation Underfloor Duct



Raceway Solutions Flush Activation Underfloor Duct provides an aesthetic wire management solution for delivering power and communications services. The new flush-style inserts, which use standard floor box covers for power and data outlets, make it the ideal underfloor duct solution for office environments, retail locations, casinos, and medical facilities. Raceway Solutions Flush Activation Underfloor Duct sets the standard for fast, easy installation by incorporating a unique one-piece duct design along with integral coupler/supports.

Raceway Solutions Flush Activation Underfloor Duct also sets the standard for application flexibility. The duct comes with activation inserts pre-assembled to the duct, or the inserts can be purchased separately for field installation only where you need them. Unique multi-gang inserts with removable voltage dividers provide the flexibility of installing multiple gangs of the same service at each insert location. In addition, the use of standard floor box covers enables a wide variety of power and data outlets.

Features & Benefits:

- **Available in 1-, 2-, and 3- compartment duct configurations**

- Unique one-piece duct reduces installation labor.
 - Welded-in dividers create separate channels for power & communications services.

- **Unique multi-gang inserts offer application flexibility**

- Removable voltage dividers allow multiple gangs of the same service at each insert location.

- Individual gangs can be activated as needed – keeps costs down.

- Afterset inserts are available for field installation – inserts only where you need them to minimize system cost.

- **Aesthetic, flush-mounted activation trims are available for both carpet and tile applications**

- Brass, aluminum and nonmetallic trims are available.

- Tile trims have after-pour adjustability to accommodate variations in tile thickness.

- **Activation trims accept standard Raceway Solutions Floor Box Covers**

- Brass, aluminum and nonmetallic covers are available.

- Complete cover offering accommodates a wide range of applications.

- **Combination coupler/supports simplify installation**

- Same part is used to join raceway sections together and to support/level the duct – reduces labor & material.

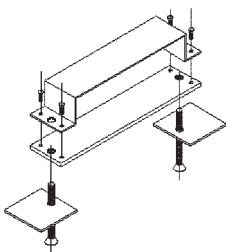
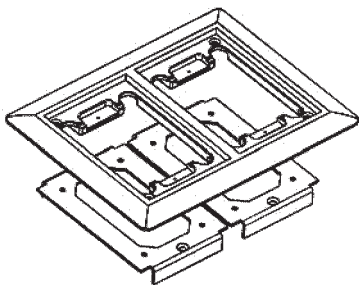
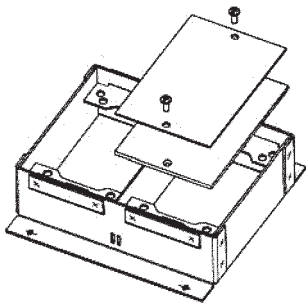
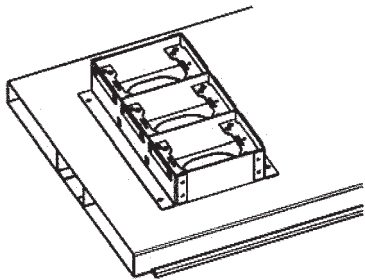

Raceway Solutions™

Flush Activation Underfloor Duct

Catalog Number System

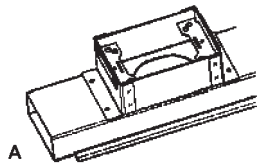

201F Series
Single Compartment

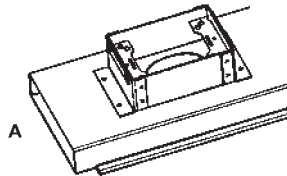

201WF Series
Wide Single Compartment

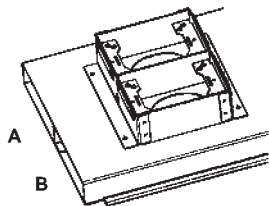

202F Series
Two Compartment

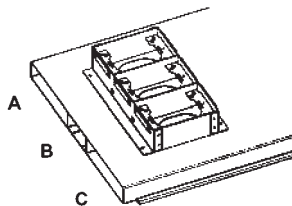

203F Series
Three Compartment

20 F

of Cells

- 1 = Single Cell
- 1W = Single Cell Wide
- 2 = Two Cell
- 3 = Three Cell

- **3** -

Insert Height

- B = Blank
- 15 = 1½" Height
- 2 = 2" Height
- 3 = 3" Height

12

Insert Spacing

- 12 & 24 Standard
- 6, 18, & 36 (optional)



Duct Sections

Cat. No.	Duct Depth	Duct Width	Compartment Width	Insert Height	Insert Spacing
201-B	1½"	3¼"	A = 3¼"	(no inserts)	(no inserts)
201F-3-24	1½"	3¼"	A = 3¼"	3"	24"
201F-2-24	1½"	3¼"	A = 3¼"	2"	24"
201F-15-24	1½"	3¼"	A = 3¼"	1½"	24"
201F-3-12	1½"	3¼"	A = 3¼"	3"	12"
201F-2-12	1½"	3¼"	A = 3¼"	2"	12"
201F-15-12	1½"	3¼"	A = 3¼"	1½"	12"
201W-B	1½"	5⅞"	A = 5⅞"	(no inserts)	(no inserts)
201WF-3-24	1½"	5⅞"	A = 5⅞"	3"	24"
201WF-2-24	1½"	5⅞"	A = 5⅞"	2"	24"
201WF-15-24	1½"	5⅞"	A = 5⅞"	1½"	24"
201WF-3-12	1½"	5⅞"	A = 5⅞"	3"	12"
201WF-2-12	1½"	5⅞"	A = 5⅞"	2"	12"
201WF-15-12	1½"	5⅞"	A = 5⅞"	1½"	12"
202-B	1½"	10"	A & B = 5"	(no inserts)	(no inserts)
202F-3-24	1½"	10"	A & B = 5"	3"	24"
202F-2-24	1½"	10"	A & B = 5"	2"	24"
202F-15-24	1½"	10"	A & B = 5"	1½"	24"
202F-3-12	1½"	10"	A & B = 5"	3"	12"
202F-2-12	1½"	10"	A & B = 5"	2"	12"
202F-15-12	1½"	10"	A & B = 5"	1½"	12"
203F-B	1½"	15"	A & C = 6" - B = 3"	(no inserts)	(no inserts)
203F-3-24	1½"	15"	A & C = 6" - B = 3"	3"	24"
203F-2-24	1½"	15"	A & C = 6" - B = 3"	2"	24"
203F-15-24	1½"	15"	A & C = 6" - B = 3"	1½"	24"
203F-3-12	1½"	15"	A & C = 6" - B = 3"	3"	12"
203F-2-12	1½"	15"	A & C = 6" - B = 3"	2"	12"
203F-15-12	1½"	15"	A & C = 6" - B = 3"	1½"	12"

All duct sections 10' long, 14 gauge pre-galvanized steel.

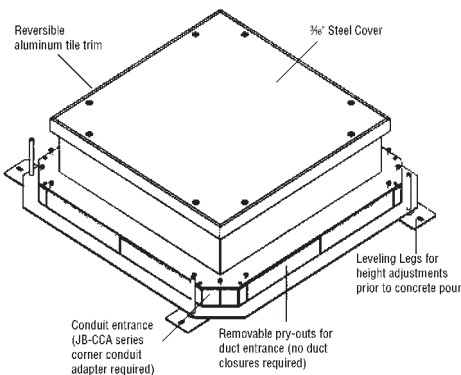

Junction Boxes

Cat. No.	Description
201-JB-3	Junction box for 201 Series Duct with 3" high inserts
201-JB-2	Junction box for 201 Series Duct with 2" high inserts
201-JB-15	Junction box for 201 Series Duct with 1½" high inserts
201W-JB-3	Junction box for 201W Series Duct with 3" high inserts
201W-JB-2	Junction box for 201W Series Duct with 2" high inserts
201W-JB-15	Junction box for 201W Series Duct with 1½" high inserts
202-JB-3	Junction box for 202 Series Duct with 3" high inserts
202-JB-2	Junction box for 202 Series Duct with 2" high inserts
202-JB-15	Junction box for 202 Series Duct with 1½" high inserts
203F-JB-3	Junction box for 203F Series Duct with 3" high inserts
203F-JB-2	Junction box for 203F Series Duct with 2" high inserts
203F-JB-15	Junction box for 203F Series Duct with 1½" high inserts



Raceway Solutions™

Flush Activation Underfloor Duct

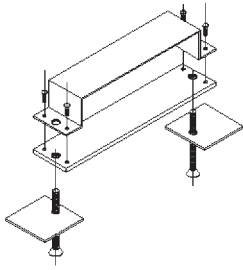

Coupler/Support

Cat. No.	Description
201-DCS	Duct Coupler/Support for 201 Series Duct
201W-DCS	Duct Coupler/Support for 201W Series Duct
202-DCS	Duct Coupler/Support for 202 Series Duct
203-DCS	Duct Coupler/Support for 203F Series Duct

Provides means for coupling duct sections together and for supporting the duct system. It is recommended that a support/coupler be used every 5' of duct run.

Material: 14 gauge pre-galvanized steel

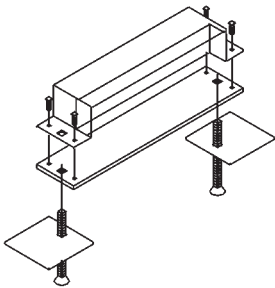

End Cap/Support

Cat. No.	Description
201-ECS	Duct End Cap/Support for 201 Series Duct
201W-ECS	Duct End Cap/Support for 201W Series Duct
202-ECS	Duct End Cap/Support for 202 Series Duct
203-ECS	Duct End Cap/Support for 203F Series Duct

Provides means for supporting and closing off unused duct ends.

Material: 14 gauge pre-galvanized steel

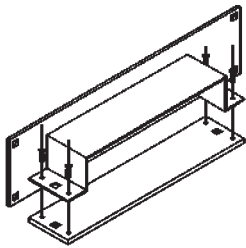

Cabinet Connector

Cat. No.	Description
201-DCC	Duct Cabinet Connector for 201 Series Duct
201W-DCC	Duct Cabinet Connector for 201W Series Duct
202-DCC	Duct Cabinet Connector for 202 Series Duct
203-DCC	Duct Cabinet Connector for 203F Series Duct

Provides means for connecting duct to an electrical cabinet.

Material: 14 gauge pre-galvanized steel

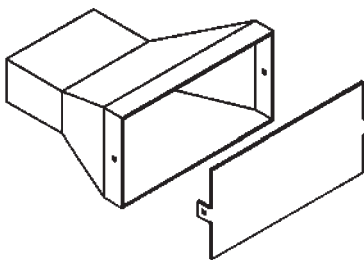

Conduit Adapter

Cat. No.	Description
201-UCA	Universal Conduit Adapter for 201 Series Duct
201W-UCA	Universal Conduit Adapter for 201W Series Duct
202-UCA	Universal Conduit Adapter for 202 Series Duct
203F-UCA	Universal Conduit Adapter for 203F Series Duct

Provides means for attaching conduit to the underfloor duct system at the junction box. The conduit adapter is inserted into a main duct entrance. The blank cover can be field-punched for the required combination of conduits.

Material: 14 gauge pre-galvanized steel

Raceway Solutions™

Flush Activation Underfloor Duct

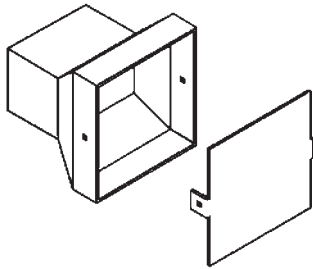

Corner Conduit Adapter

Cat. No.	Description
JB-CCA-B	Corner Conduit Adapter with blank cover
JB-CCA-1/2	Corner Conduit Adapter with 1/2" KO
JB-CCA-3/4	Corner Conduit Adapter with 3/4" KO
JB-CCA-1	Corner Conduit Adapter with 1" KO
JB-CCA-1-1/2	Corner Conduit Adapter with 1 1/2" KO
JB-CCA-2	Corner Conduit Adapter with 2" KO

Provides means for attaching conduit to the underfloor duct system at the junction box. The corner conduit adapter is inserted into the corner conduit entrance of any size junction box.
Material: 14 gauge pre-galvanized steel

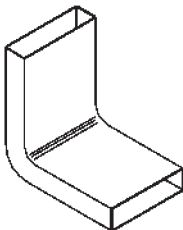

Vertical Elbow

Cat. No.	Description
201-VEL	Vertical Elbow for 201 Series Duct
201W-VEL	Vertical Elbow for 201W Series Duct
202-VEL	Vertical Elbow for 202 Series Duct
203F-VEL	Vertical Elbow for 203F Series Duct

Material: 14 gauge pre-galvanized steel

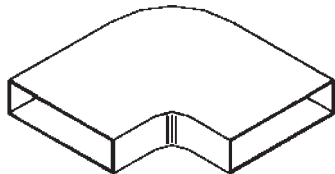

Horizontal Elbow

Cat. No.	Description
201-HB90	Horizontal 90° Elbow for 201 Series Duct
201W-HB90	Horizontal 90° Elbow for 201W Series Duct
202-HB90	Horizontal 90° Elbow for 202 Series Duct
203F-HB90	Horizontal 90° Elbow for 203F Series Duct

Material: 14 gauge pre-galvanized steel

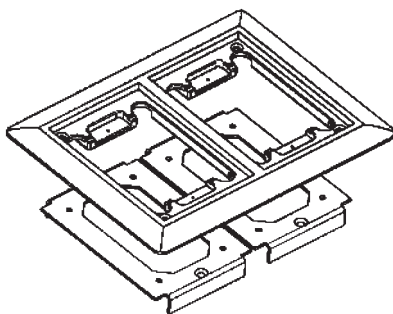

Carpet Activations

Cat. No.	Description	Color
FACA-1G-AL	1-Gang Carpet Activation	Aluminum
FACA-1G-B	1-Gang Carpet Activation	Brass
FACA-1G-BGE	1-Gang Carpet Activation	Nonmetallic - Beige
FACA-1G-BLK	1-Gang Carpet Activation	Nonmetallic - Black
FACA-1G-GRY	1-Gang Carpet Activation	Nonmetallic - Gray
FACA-2G-AL	2-Gang Carpet Activation	Aluminum
FACA-2G-B	2-Gang Carpet Activation	Brass
FACA-2G-BGE	2-Gang Carpet Activation	Nonmetallic - Beige
FACA-2G-BLK	2-Gang Carpet Activation	Nonmetallic - Black
FACA-2G-GRY	2-Gang Carpet Activation	Nonmetallic - Gray
FACA-3G-AL	3-Gang Carpet Activation	Aluminum
FACA-3G-B	3-Gang Carpet Activation	Brass
FACA-3G-BGE	3-Gang Carpet Activation	Nonmetallic - Beige
FACA-3G-BLK	3-Gang Carpet Activation	Nonmetallic - Black
FACA-3G-GRY	3-Gang Carpet Activation	Nonmetallic - Gray



Raceway Solutions™

Flush Activation Underfloor Duct

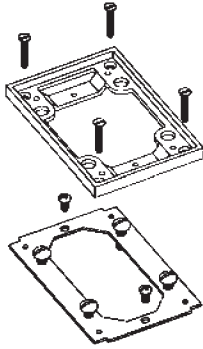

Tile Activations

Cat. No.	Description	Color
FATA-AL	Tile Activation	Aluminum
FATA-B	Tile Activation	Brass
FATA-BGE	Tile Activation	Nonmetallic - Beige
FATA-BLK	Tile Activation	Nonmetallic - Black
FATA-GRY	Tile Activation	Nonmetallic - Gray

Note: One Tile Activation is required for each gang of the insert.
Provides means for height adjustment after the concrete pour to accommodate different tile thickness.

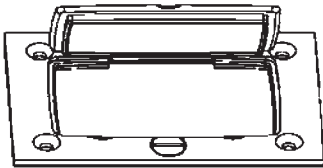
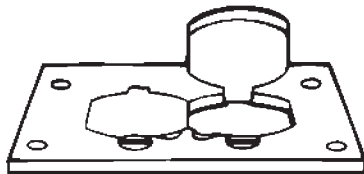
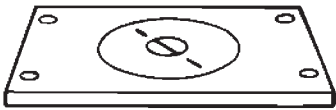

Metallic Covers

Cat. No.	Description	Color
FA-MCP-1/2-B	Cover Plate w/ 1/2" NPS Plug	Brass
FA-MCP-1/2-AL	Cover Plate w/ 1/2" NPS Plug	Aluminum
FA-MCP-3/4-B	Cover Plate w/ 3/4" NPS Plug	Brass
FA-MCP-3/4-AL	Cover Plate w/ 3/4" NPS Plug	Aluminum
FA-MCP-1-B	Cover Plate w/ 1" NPS Plug	Brass
FA-MCP-1-AL	Cover Plate w/ 1" NPS Plug	Aluminum
FA-MCP-1-1/4-B	Cover Plate w/ 1 1/4" NPS Plug	Brass
FA-MCP-1-1/4-AL	Cover Plate w/ 1 1/4" NPS Plug	Aluminum
FA-MCP-2-B	Cover Plate w/ 2" UN plug	Brass
FA-MCP-2-AL	Cover Plate w/ 2" UN plug	Aluminum
FA-MCP-1/2-2-B	Cover Plate w/ 2" UN & 1/2" NPS plugs	Brass
FA-MCP-1/2-2-AL	Cover Plate w/ 2" UN & 1/2" NPS plugs	Aluminum
FA-MCP-3/4-2-B	Cover Plate w/ 2" UN & 3/4" NPS plug	Brass
FA-MCP-3/4-2-AL	Cover Plate w/ 2" UN & 3/4" NPS plug	Aluminum
FA-MCP-2-5/8-B	Cover Plate w/ 2 5/8" UN plug	Brass
FA-MCP-2-5/8-AL	Cover Plate w/ 2 5/8" UN plug	Aluminum
FA-MCP-DP-B	Cover Plate w/ Two 1 7/16" Plugs for Duplex	Brass
FA-MCP-DP-AL	Cover Plate w/ Two 1 7/16" Plugs for Duplex	Aluminum
FA-MCP-FDP-B	Cover Plate w/ Two Flip Lids for Duplex	Brass
FA-MCP-FDP-AL	Cover Plate w/ Two Flip Lids for Duplex	Aluminum
FA-MCP-GFCI-B	Cover Plate w/ One Flip Lid for GFCI	Brass

Nonmetallic Covers

Cat. No.	Description	Color
FAPCP-U-BGE	Universal Cover Plate for Duplex & GFCI	Beige
FAPCP-U-BLK	Universal Cover Plate for Duplex & GFCI	Black
FAPCP-U-GRY	Universal Cover Plate for Duplex & GFCI	Gray
FAPCP-BP-BGE	Blank Cover Plate	Beige
FAPCP-BP-BLK	Blank Cover Plate	Black
FAPCP-BP-GRY	Blank Cover Plate	Gray

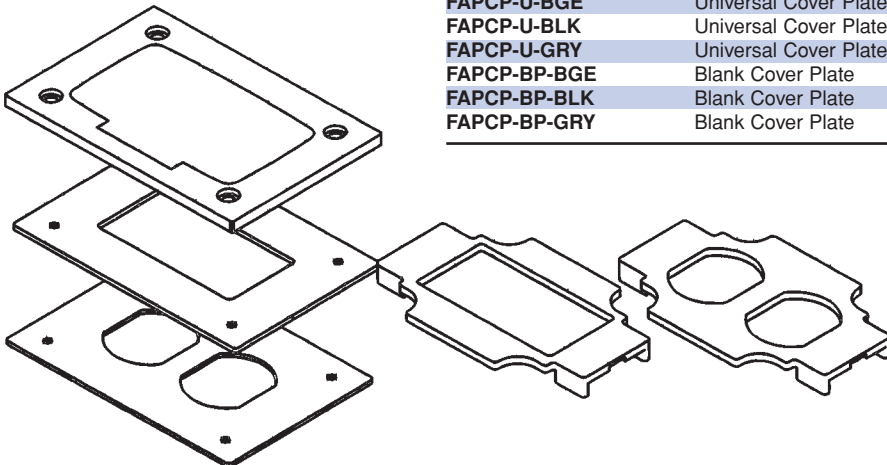

Raceway Solutions™

Flush Activation Underfloor Duct

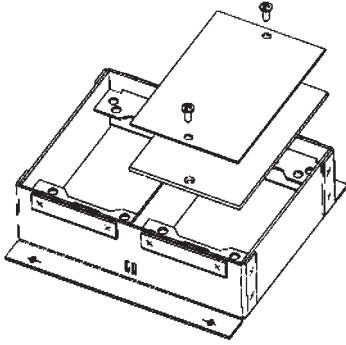

Afterset Inserts

Cat. No.	Description	Insert Height
DAIFA-1G-3	1-Gang Afterset Insert	3"
DAIFA-1G-2	1-Gang Afterset Insert	2"
DAIFA-1G-15	1-Gang Afterset Insert	1½"
DAIFA-2G-3	2-Gang Afterset Insert	3"
DAIFA-2G-2	2-Gang Afterset Insert	2"
DAIFA-2G-15	2-Gang Afterset Insert	1½"
DAIFA-3G-3	3-Gang Afterset Insert	3"
DAIFA-3G-2	3-Gang Afterset Insert	2"
DAIFA-3G-15	3-Gang Afterset Insert	1½"

Provides means to add activation inserts in the field after installation of the duct.

Material: 14 gauge pre-galvanized steel

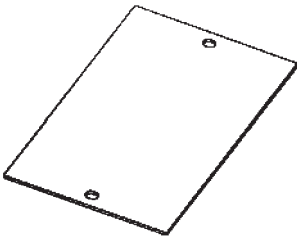

Compartment Cover

Cat. No.	Description
FAD-CC	Compartment Cover

Provides means to cover the opening in the duct which provides access compartment wiring. Wiring from a different compartment can then be routed into the gang and activated (used when multiple outlets of the same service are required at the same insert location).

Material: 18 gauge pre-galvanized steel

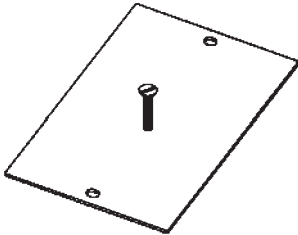

Marker Caps

Cat. No.	Description
FAD-MC-Z	Insert Marker Cap with Zinc Screw
FAD-MC-B	Insert Marker Cap with Brass Screw

Raceway Solutions™

Flush Activation Underfloor Duct

Wirefill Chart

				201	201W	202		203F		
				CHANNEL A	CHANNEL A	CHANNEL A	CHANNEL B	CHANNEL A	CHANNEL B	CHANNEL C
CHANNEL CROSS SECTIONAL AREA (SQUARE INCHES):				4.38	7.78	6.60	6.60	5.90	4.07	5.90
COAX CABLES	RG6 /u	DIA. = 0.270"	40% FILL	30	54	46	46	41	28	41
	RG11 /u	DIA. = 0.405"	40% FILL	13	24	20	20	18	12	18
	RG58 /u	DIA. = 0.193"	40% FILL	60	106	90	90	80	55	80
	RG59 /u	DIA. = 0.242"	40% FILL	38	67	57	57	51	35	51
	RG62A /u	DIA. = 0.242"	40% FILL	38	67	57	57	51	35	51
LAN CABLES	CAT5,4 pr. UNSHIELDED	DIA. = 0.250"	40% FILL	35	63	53	53	48	33	48
FIBER OPTIC CABLES 62.5 /125 um	2 STRAND	DIA. = 0.175"	40% FILL	73	129	110	110	98	67	98
	4 STRAND	DIA. = 0.175"	40% FILL	73	129	110	110	98	67	98
	6 STRAND	DIA. = 0.210"	40% FILL	50	89	76	76	68	47	68
SIGNAL CABLES	18 AWG	DIA. = 0.066"	40% FILL	515	915	776	776	694	478	694
	20 AWG	DIA. = 0.057"	40% FILL	700	1240	1050	1050	944	650	944
	22 AWG	DIA. = 0.050"	40% FILL	922	1630	1380	1380	1240	856	1240
	24 AWG	DIA. = 0.044"	40% FILL	1160	2070	1760	1760	1570	1080	1570
POWER (THHN)	10 AWG	DIA. = 0.164"	40% FILL	83	147	125	125	111	77	111
	12 AWG	DIA. = 0.130"	40% FILL	132	235	200	200	178	123	178
	14 AWG	DIA. = 0.111"	40% FILL	182	324	275	275	245	169	245

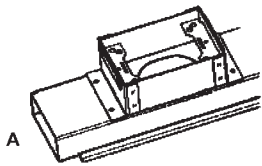

201 Series
Single Compartment

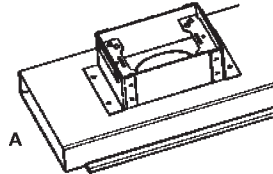

201W Series
Wide Single Compartment

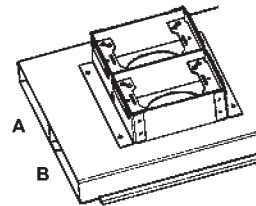

202 Series
Two Compartment

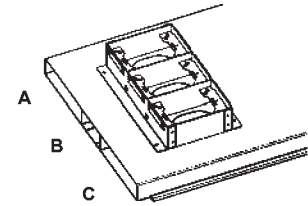

203F Series
Three Compartment